













**WT 370**

# Technical Data

LIFETIME EXCELLENCE



## TECHNICAL SPECIFICATIONS

	Total weight *	17600 kg		max. outreach	27,80 m
	Overall length	9,95 m		Rotation angle of turntable	540 °
	Width in transport position	2,55 m		Rotation angle of cage	2 x 85°
	Height in transport position	3,76 m		Rotation angle of cage boom	175°
	max. stabiliser width	6,2 m		Size of cage	3,88 x 1,05 x 1,10 m
	max. working height	37 m		max. cage load	600 kg
	max. cage bottom height	35 m			

\* Depends on truck chassis

## WORKING DIAGRAMS

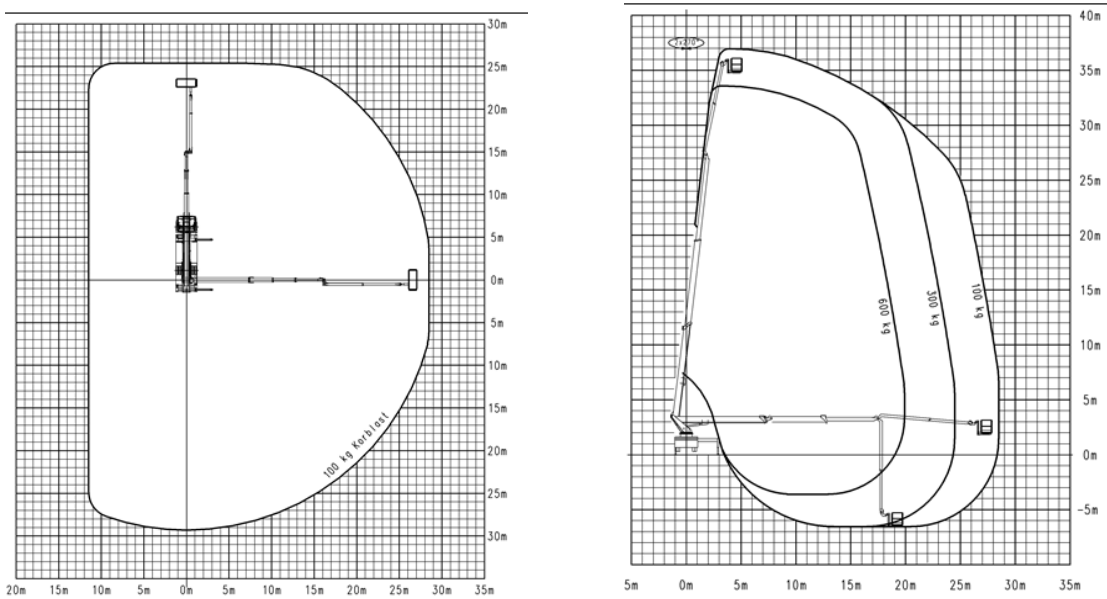

A possible 2% tolerance is contingent on structural components

## DIMENSIONS

